

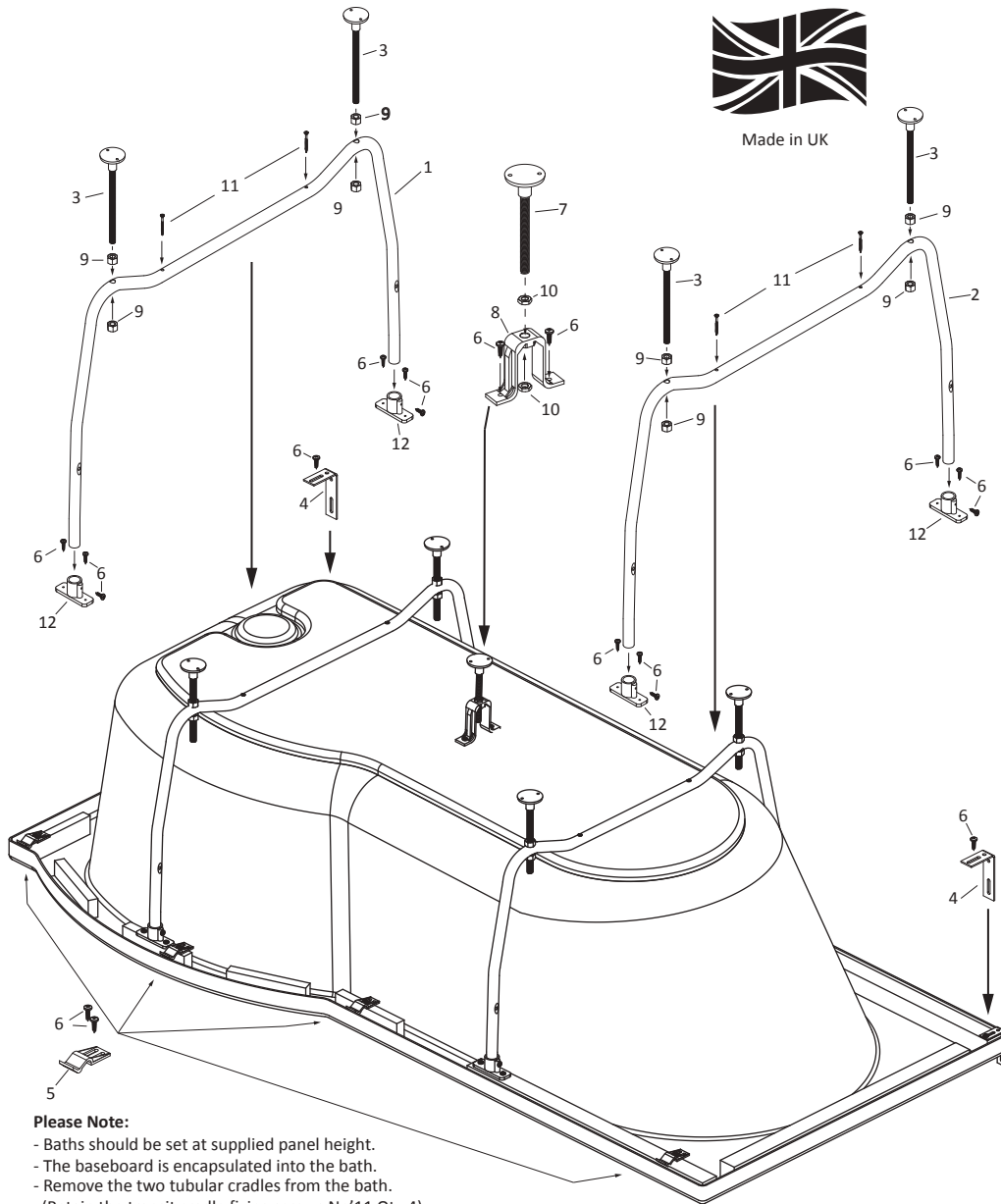

Made in UK



Please Note:

- Baths should be set at supplied panel height.
- The baseboard is encapsulated into the bath.
- Remove the two tubular cradles from the bath.
(Retain the transit cradle fixing screws No'11 Qty 4)
- Align the cradle and hand screw directly into the base of the bath using the transit cradle fixing screws.
(Important! YOU MUST CHECK THE SCREW LENGTH FIRST)
- Half the panel clips supplied should be secured (if possible) to the floor.
- Panel clips are not required on double ended baths.
- Before the final fixing of the bath, fit tap and waste fittings using a suitable sealing compound. When complete place the bath into position, re-check levels and make any final adjustments necessary. Finally secure the feet to the floor and the wall brackets to the wall. Movement may occur if not fitted correctly.
- CHECK THAT THE BATH RIM IS LEVEL.

Quality Acrylic Baths

Manufactured in the UK

P Shape Bath Installation Instructions

- Read through the instruction booklet first before commencing any work. If you are unsure of any aspect of the installation, we recommend you contact a reputable tradesperson.
- Prior to fitting your bath, carefully remove all the packaging and film from the bath and examine the bath for damage and suitability of colour match.
- Check the panel fit and match prior to installation.
- Any refixing costs or claims for wrong colour match and/or any other fault will not be accepted after fixing.

No claims for the above will be accepted once the bath is fitted.

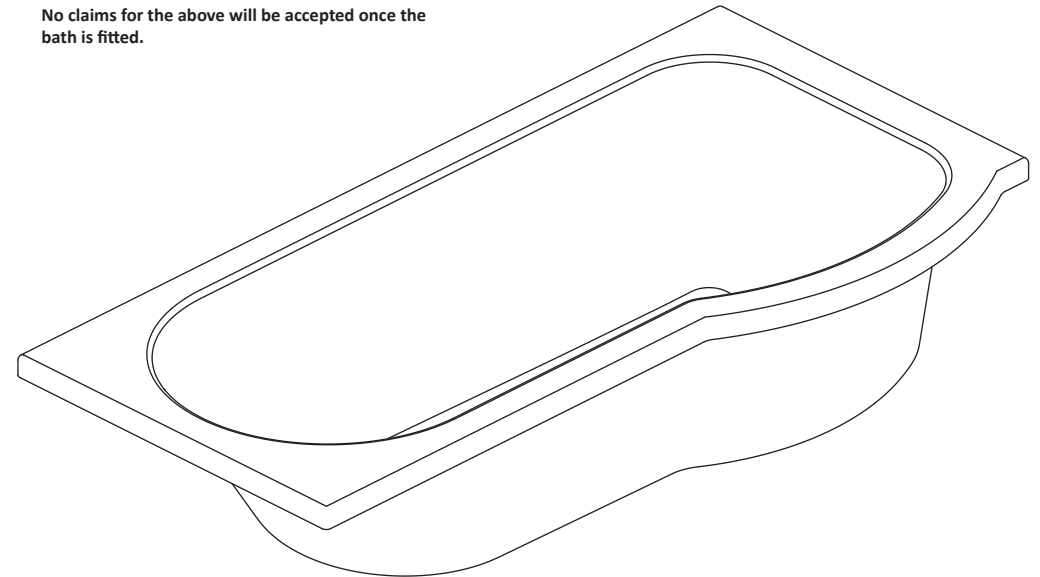

Please note, RH P-Shape bath shown for illustrational purposes.

25
Year
Guarantee

P Shape Bath

Installation Instructions

Before you start

- Before fixing remove ALL protective covering and examine carefully. The polythene film must be removed in full and the bath checked for any visible damage.
- Unpack and check the product is complete and undamaged.
- Have the correct tools available.
- Please notify the retailer immediately of any damage or faults. The manufacturer cannot be held responsible for any installation costs that may arise from damaged or faulty product being installed. The guarantee does not cover impact related damage. Please dispose of all packaging with due regard to the environment.

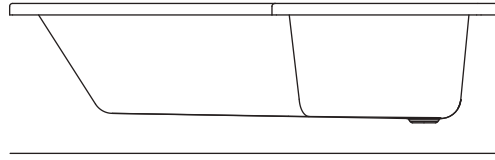

Safety

- Handle the bath with care.
- This product is heavy and requires two persons to carry.
- When drilling walls, check first for hidden pipes and cables.
- Use safety eyewear when drilling.
- Keep small parts away from children.

Tools required

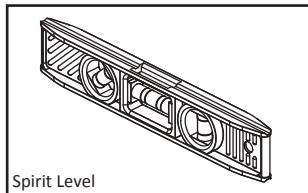

Spirit Level

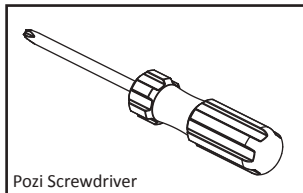

Pozi Screwdriver

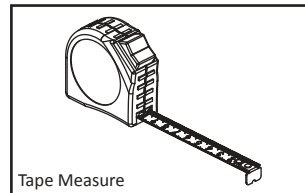

Tape Measure

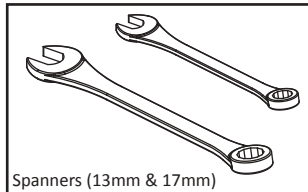

Spanners (13mm & 17mm)

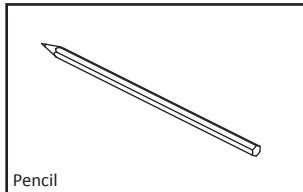

Pencil

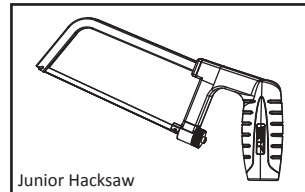

Junior Hacksaw

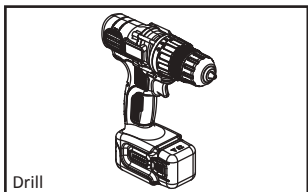

Drill

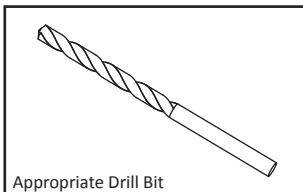

Appropriate Drill Bit

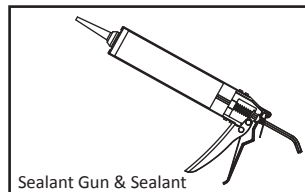

Sealant Gun & Sealant

*Tools shown not supplied

*Ensure drill bit used is suitable for wall surface!

Parts provided

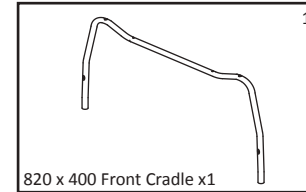

820 x 400 Front Cradle x1

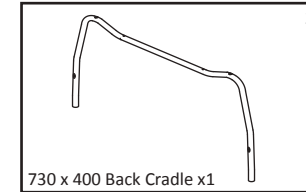

730 x 400 Back Cradle x1

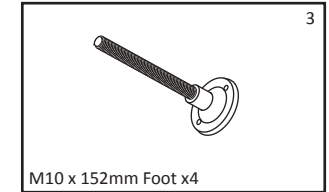

M10 x 152mm Foot x4

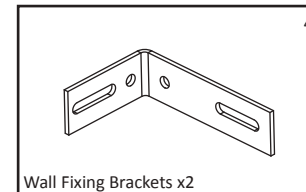

Wall Fixing Brackets x2

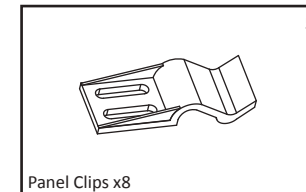

Panel Clips x8



16mm Self Tapping Screws x32

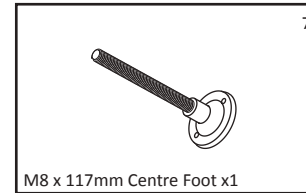

M8 x 117mm Centre Foot x1

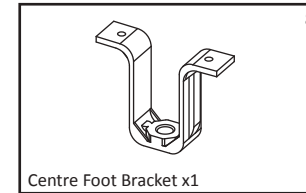

Centre Foot Bracket x1

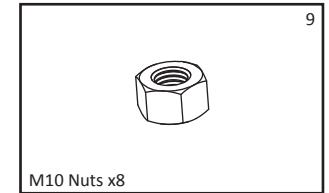

M10 Nuts x8

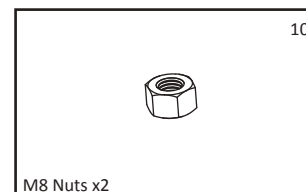

M8 Nuts x2

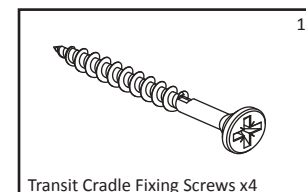

Transit Cradle Fixing Screws x4

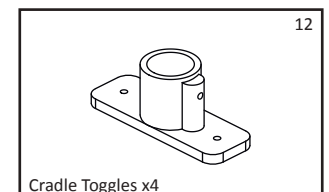

Cradle Toggles x4

- We have taken great care to ensure that this product reaches you in perfect condition. However should any parts be damaged or missing please contact your point of purchase. This does not affect your statutory rights. In addition if you require replacement parts your point of purchase will be happy to assist.

- You may have additional spare parts, please discard with due regard to the environment.

4. Using suitable fixings secure the panel clips along the edge of the marked line on the floor, aligning to the panel clips attached to the underside of the bath. (see Fig. 2)



Made in UK

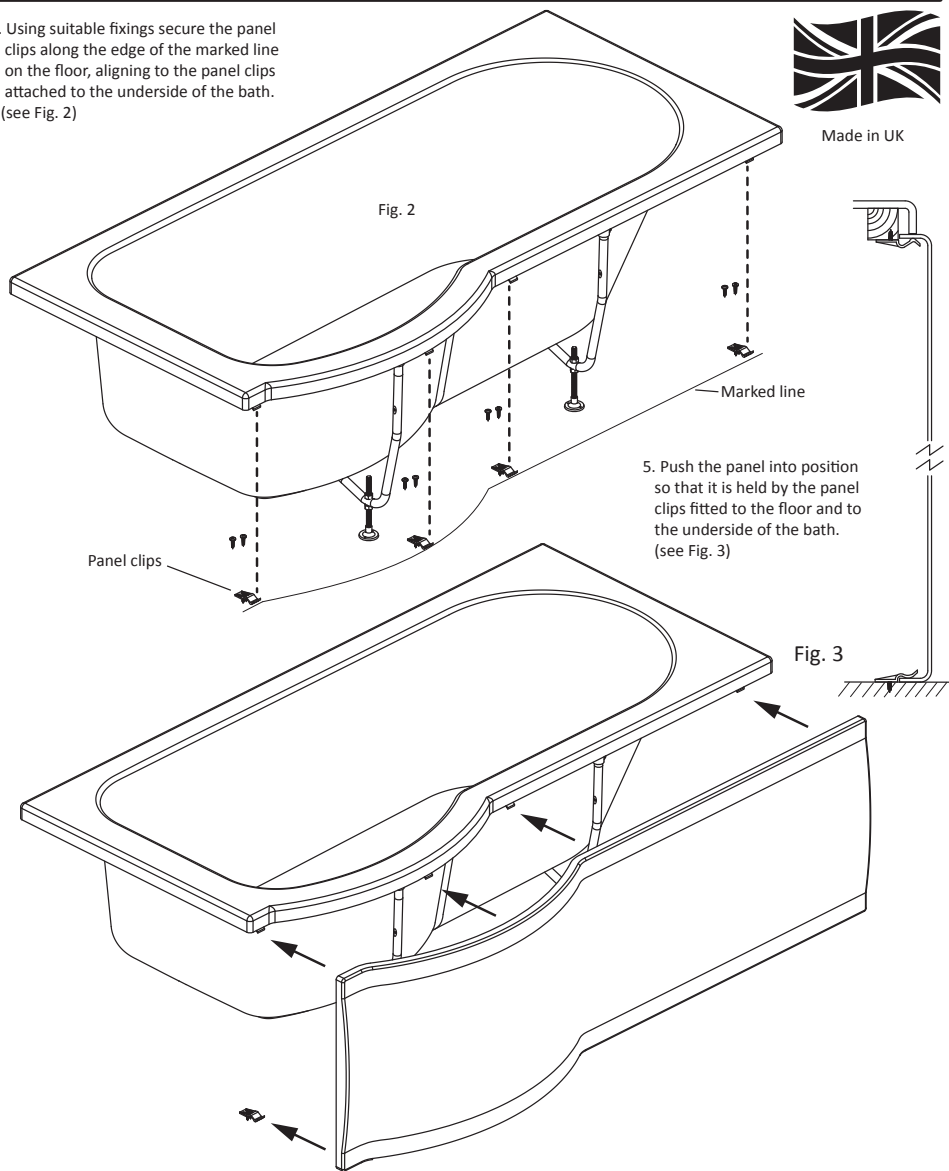

5. Push the panel into position so that it is held by the panel clips fitted to the floor and to the underside of the bath. (see Fig. 3)

Care & Use:

- Clean using warm soapy water only.
- Do not use scourers, abrasives or chemical cleaners.

Please Note:

- Baths should be set at supplied panel height.

1020
V1/280617

Quality Bath Panels

Manufactured in the UK

**Shaped Bath Panel
Installation Instructions**

- Read through the instruction booklet first before commencing any work. If you are unsure of any aspect of the installation, we recommend you contact a reputable tradesperson.
- Prior to fitting your panel, carefully remove all the packaging and film from the panel and examine the panel for damage and suitability of colour match.
- Check the panel fit and match prior to installation.
- Any refixing costs or claims for wrong colour match and/or any other fault will not be accepted after fixing.

No claims for the above will be accepted once the bath is fitted.

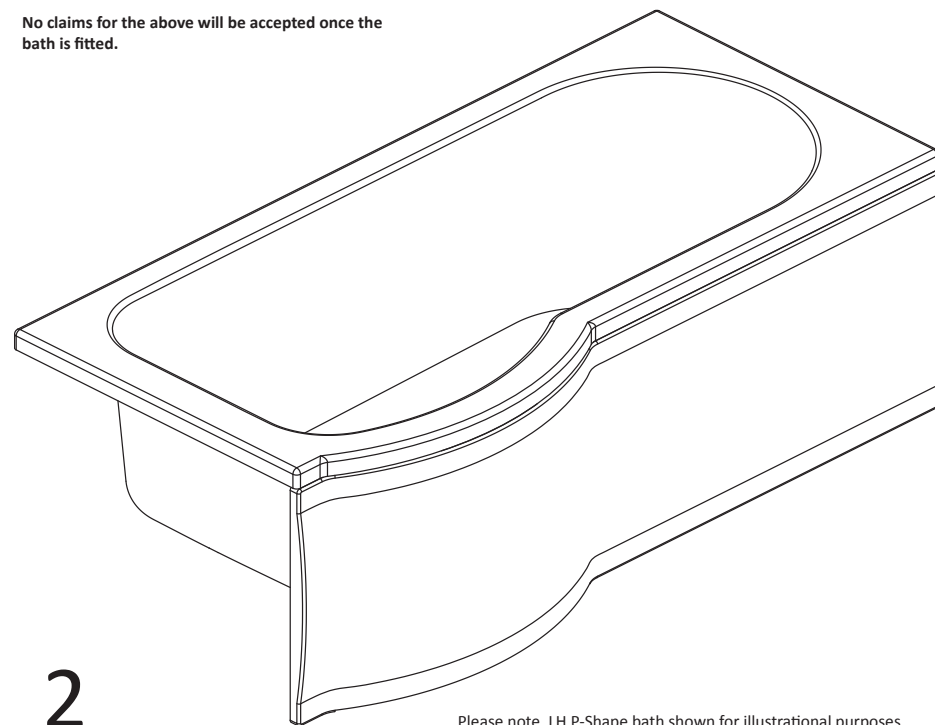

Please note, LH P-Shape bath shown for illustrational purposes.

2

Year
Guarantee

Shaped Bath Panel Installation Instructions

Before you start

- Before fixing remove ALL protective covering and examine carefully. The polythene film must be removed in full and the panel checked for any visible damage.
- Unpack and check the product is complete and undamaged.
- Have the correct tools available.
- Please notify the retailer immediately of any damage or faults. The manufacturer cannot be held responsible for any installation costs that may arise from damaged or faulty product being installed. The guarantee does not cover impact related damage. Please dispose of all packaging with due regard to the environment.

Please note: Read the installation instruction first. Although these instructions are comprehensive, it is always recommended that a technically competent installer should undertake installation.

Safety

- Handle the panel with care.
- Should the cutting of panels be necessary (due to water pipes or skirting boards) a small fine toothed saw or sharp knife is recommended.
- When drilling walls or floors, check first for hidden pipes and cables.
- Use safety eyewear when drilling.
- Keep small parts away from children.

Parts provided

Bath front panel (A)

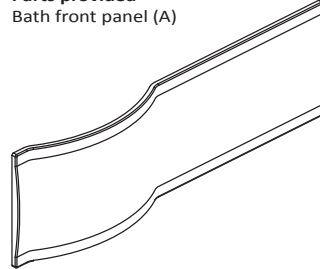

Parts Required (not supplied)

Suitable fixings for the panel clips to the floor.

Tools required

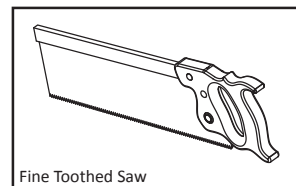
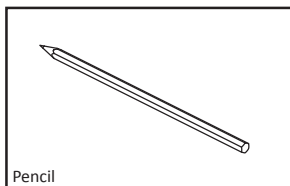
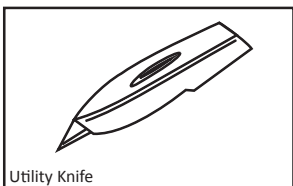
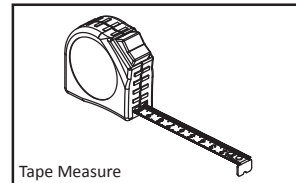
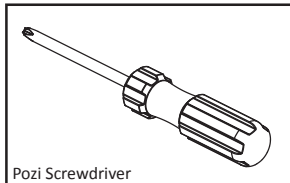
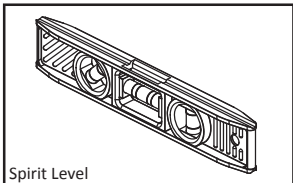

*Tools shown not supplied

- We have taken great care to ensure that this product reaches you in perfect condition. However should any parts be damaged or missing please contact your point of purchase. This does not affect your statutory rights. In addition if you require replacement parts your point of purchase will be happy to assist.

Assembly

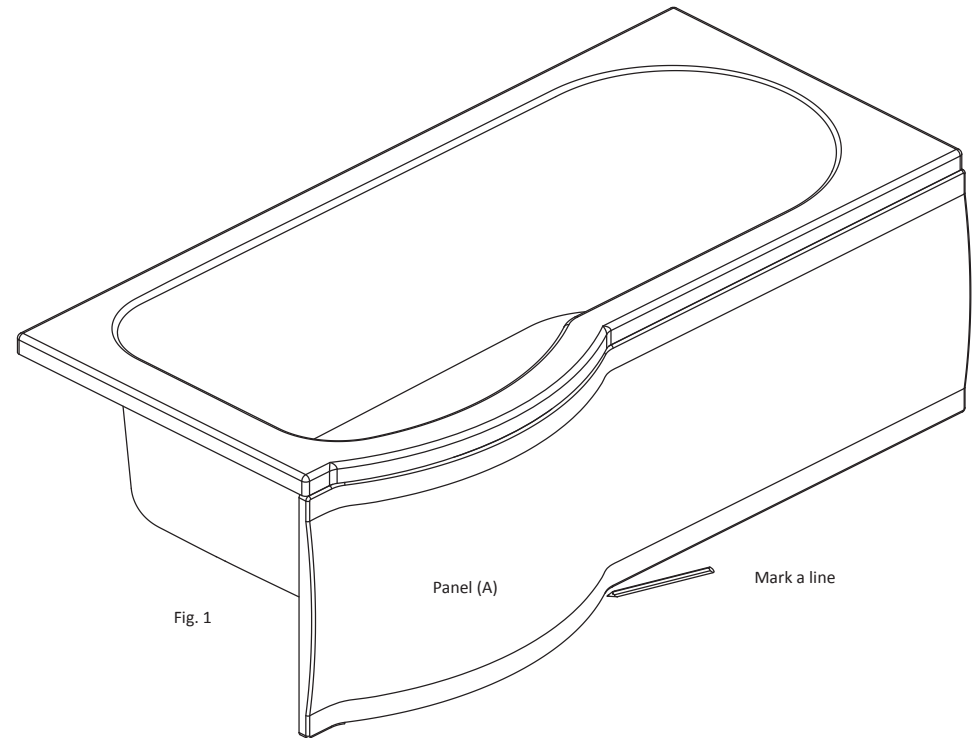

1. Place the bath panel into position.
(See Fig. 1)

2. Ensure that the panel is vertical using a spirit level.

Note - If fitting both the end and front panel check that the end panel is located behind the front panel at the corner joint.

3. Mark a line on the floor along the length of the panel then remove the panel.
(See Fig. 1)

P Shape Screen with Towel Rail Installation Instructions

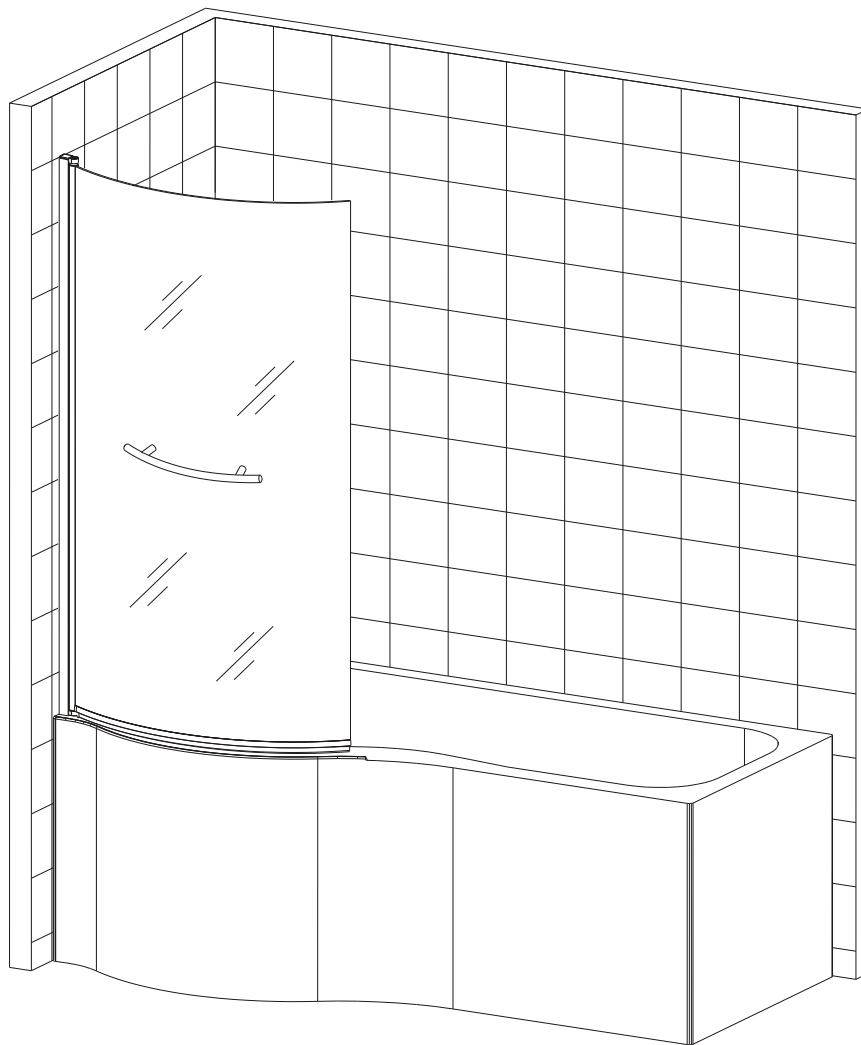

1400x710mm

- Please read these instructions in full before installing









IMPORTANT

- Check that the bathtub has been installed to the manufacturer's instructions. Please note - All product is supplied without a bathtub.
- Opening wall adjustments
P Shape screen - adjustment = 695 - 710 mm

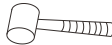
GENERAL SAFETY INSTRUCTIONS

- Do not fix the wall profile to newly plastered, painted or papered walls as chemical reaction may cause discolouration to the surface finish.
- Important: The wall plugs included in this pack are for solid walls only. If the product is to be mounted on a partition or stud wall, specialised fixings should be purchased separately.
- Fixing tips; A piece of insulating tape or a couple of layers of masking tape applied to the wall before marking out the fixing holes will help stop the drill from wandering, particularly on tiled surfaces.
- When working near a basin or bath insert the plug into the waste, this will help you avoid losing small parts. Also take care not to drop accessories or tools onto the bath or basin, use a towel or bathmat to protect delicate surfaces.
- **CAUTION!**
Before drilling into any walls check that there are no hidden cables or pipes. Exercise great care when using power tools near water. The use of a residual current device (RCD) or cordless drill is recommended. Always double check the positioning and measurements before drilling holes.
- This product is heavy and requires two people during lifting and operations.
- Glass is delicate, support on cardboard to minimise risk of damage.



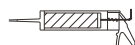



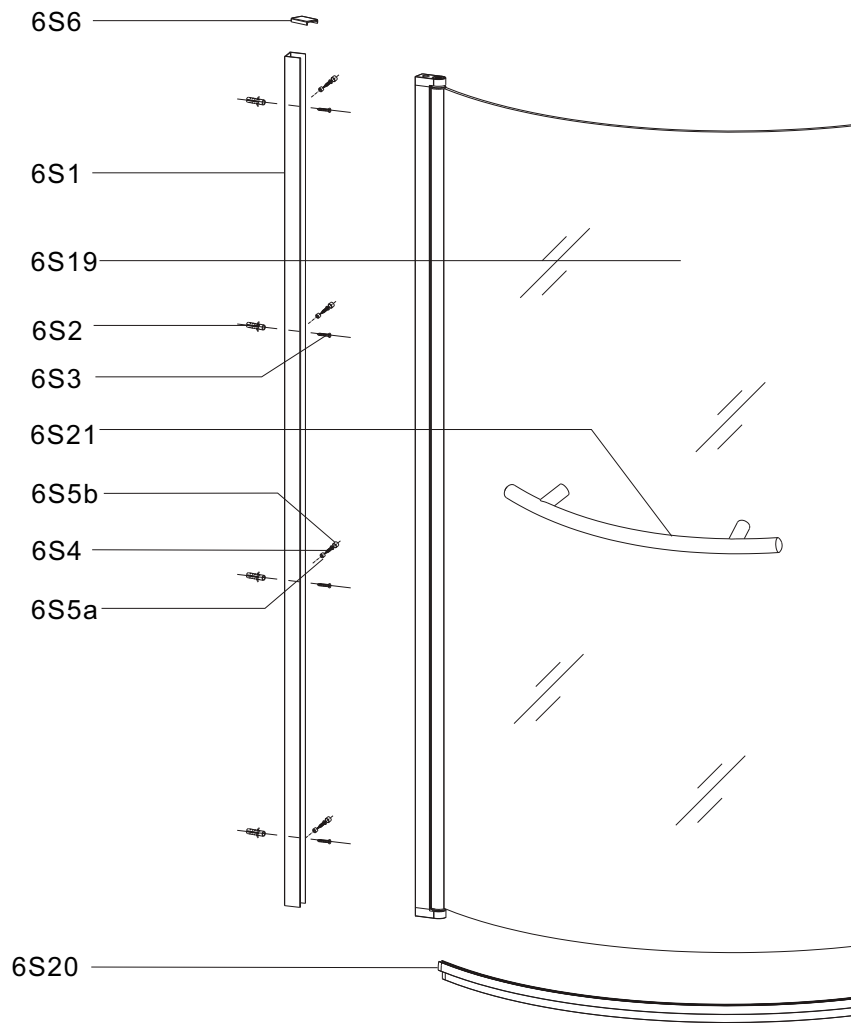

Tools required (not supplied)

| | | | |
|------------------------|---|------------------|---|
| Electric drill |  | tape measure |  |
| drill(Ø3.2mm) |  | rubber hammer |  |
| drill(Ø6mm) |  | knife |  |
| cross tip screw driver |  | pencil |  |
| spirit level |  | silicone sealant |  |

IDENTIFICATION OF PARTS



Fixings & fittings supplied

| Item No.: | Part | Quantity | Item No.: | Part | Quantity |
|-----------|--|----------|-----------|---|----------|
| 6S1 |  | X 1 | 6S6 |  | X 1 |
| 6S2 |  | X 4 | 6S19 |  | X 1 |
| 6S3 |  ST4X30 | X 4 | 6S20 |  | X 1 |
| 6S4 |  ST4X10 | X 4 | 6S21 |  | X 1 |
| 6S5 |  | X 4 | | | |

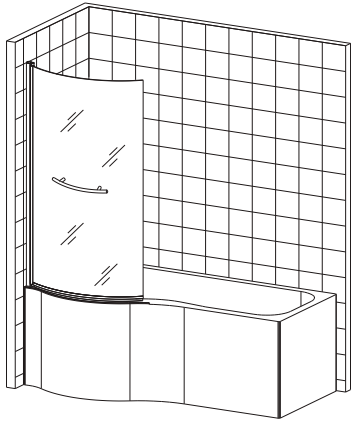

LH

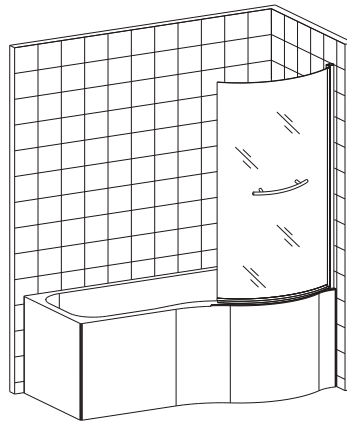

RH

P shape screen is ok to be installed in left and right hand. Below steps are based on left hand. For right hand, please turn the screen panel upside down and follow below steps in mirror direction.

1.

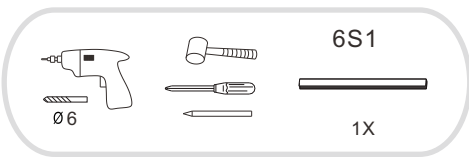

- Ensure the bath is level and sealed correctly before installation.
- Put the wall profile 6S1 against the wall, ensuring the distance between the profile and the bathtub edge is correct. Adjust the profile to make sure it is vertical by using a spirit level.
- Mark the holes on the wall.
- Drill the holes ($\phi 6\text{mm}$) according to the marks.

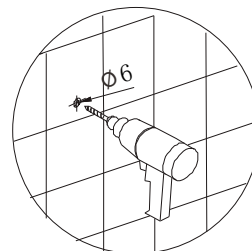
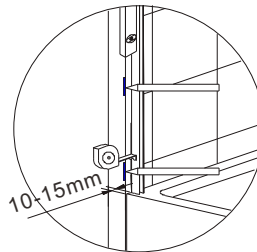
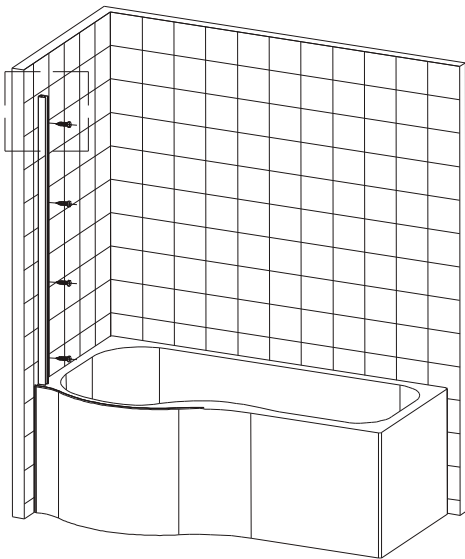

2.

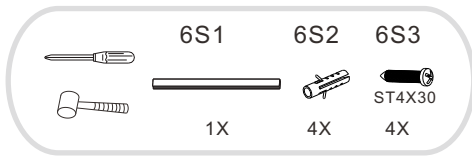

- Insert wall plugs 6S2(4X) into the holes.
- Fix wall profile 6S1 on the wall with screws 6S3(4X).

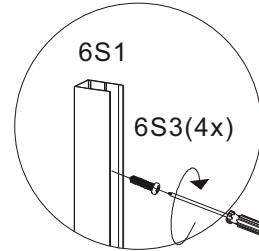
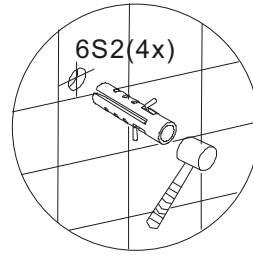
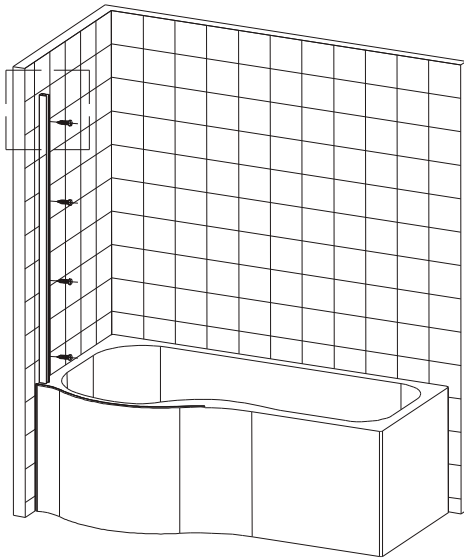

3.

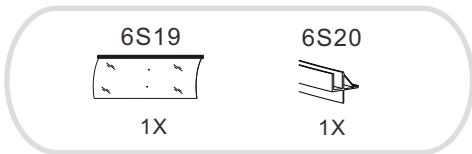

- Apply bottom sealer 6S20 on the bottom of glass panel 6S19.

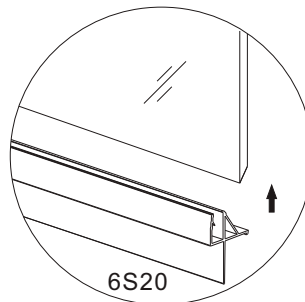
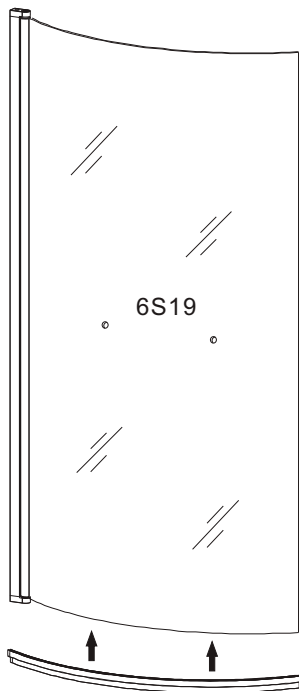

Caution:
The triangle bubble should be mounted towards inside of the bathtub.

4.

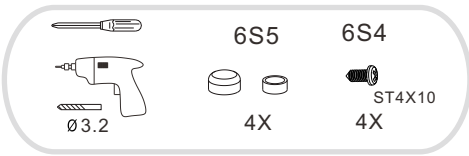

- Insert vertical profile into wall profile. There is 15mm adjustment between vertical profile and wall profile. Please adjust the screen panel in correct position and make sure glass panel fits along the bath edge, but does not sit down directly on bathtub edge.
- From inside drill through the vertical profile and into wall profile where shown, using a $\phi 3.2$ mm drill bit.
- Fix the parts together using screws 6S4(4X) and screw seats and caps 6S5(4X).

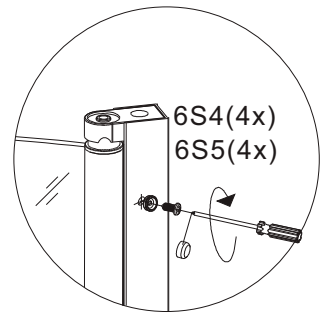
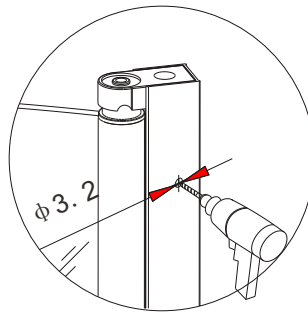
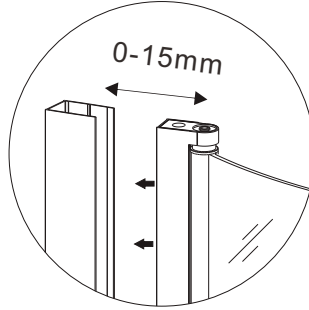
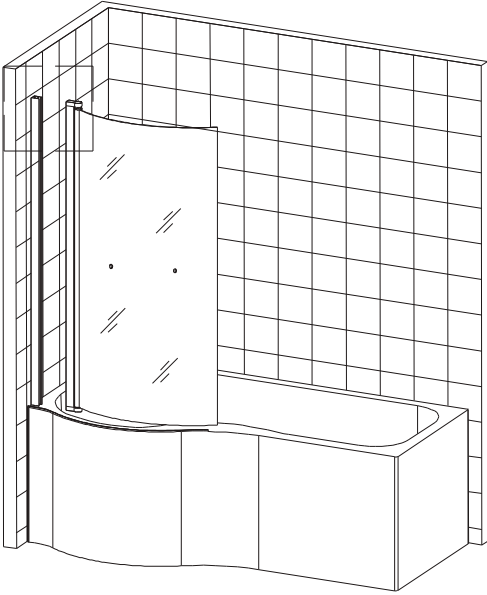

5.

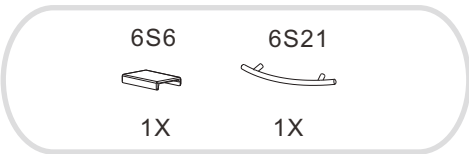

- Cover the wall profile with top cap 6S6.
- Mount towel rail 6S21 on the screen panel.

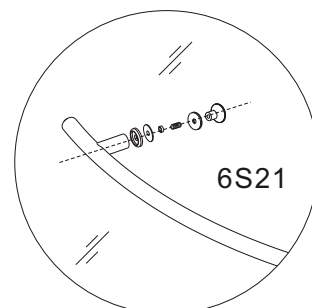
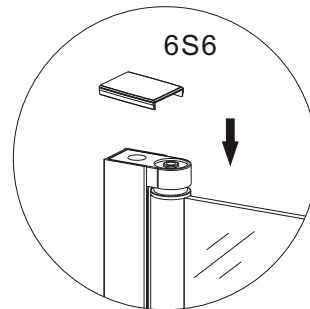
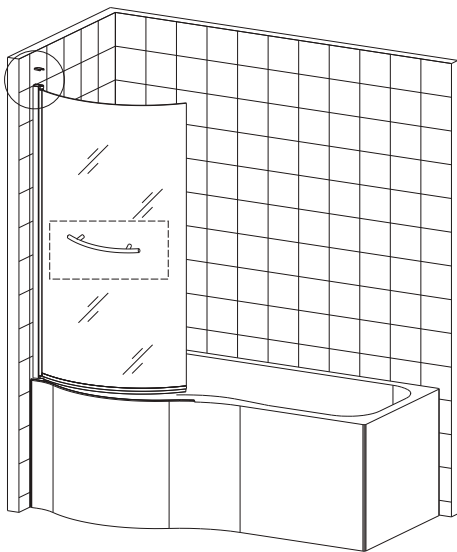

6.

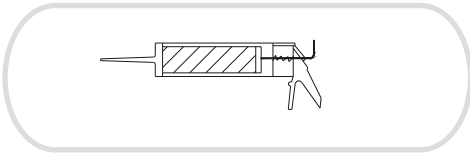

- Apply silicone sealant to the outside of the enclosure.
Please note: Do not apply silicone sealant to the inside of the enclosure.

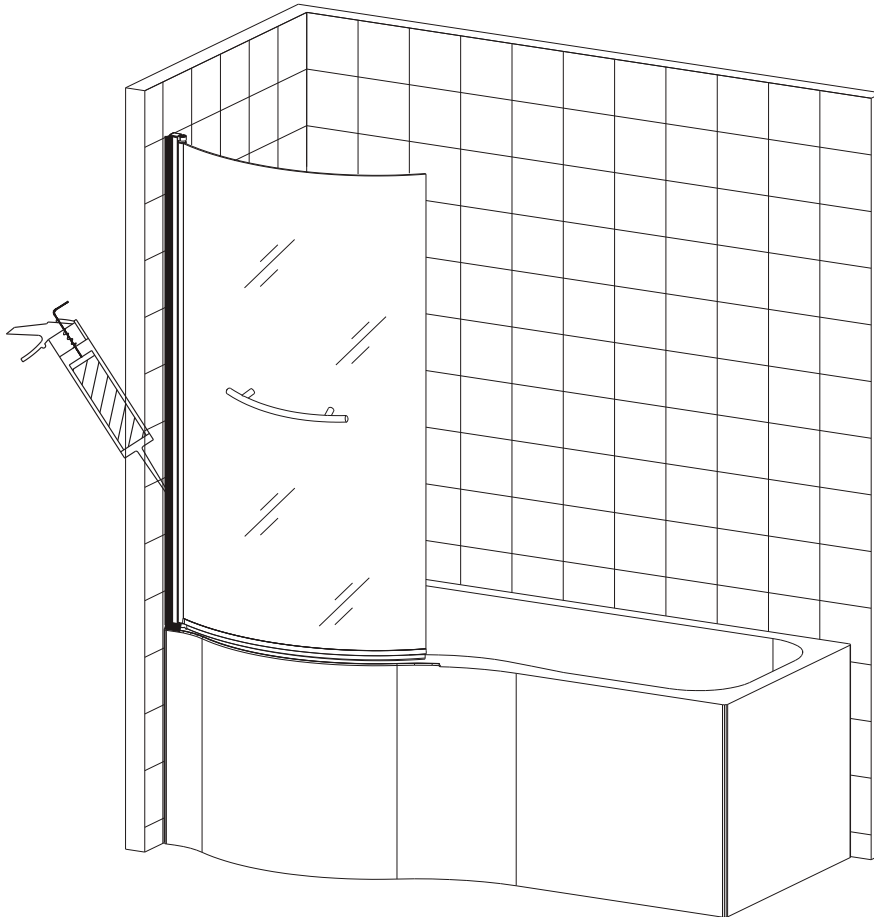
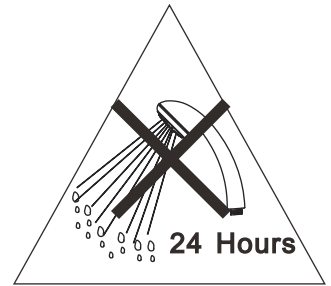

Cleaning and Maintenance:

Please do not use abrasive or strong cleaning solution on the shower enclosure, such as alcohol, petroleum liquids or any other chemical cleaner with acidic contents.
Should there be any dirty stains on the shower enclosure, please clean it with a soft lint free cloth and warm soapy water. Please rinse it with clean water afterwards.

We have taken great care to ensure that this product reaches you in perfect condition. However should any parts be damaged or missing, please contact your point of purchase. This does not affect your statutory rights. In addition, if you require replacement parts, your point of purchase will be happy to assist.